

LICITACIÓN PÚBLICA N° 01/2020







P.B.C.P.





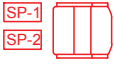

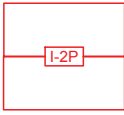
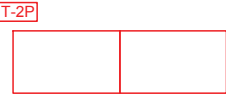

ANEXO II – PLANOS

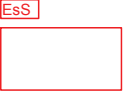
ÍNDICE DE PLANOS:

- 01-01 – Arquitectura – Planta Baja
- 01-02 – Arquitectura – Planta Baja – Gráfica
- 01-03 – Arquitectura – 1° piso
- 01-04 – Arquitectura – 1° piso – Gráfica
- 01-05 – Arquitectura – 2° piso
- 01-06 – Arquitectura – 2° piso – Gráfica
- 01-07 – Arquitectura – 3° piso
- 01-08 – Arquitectura – 3° piso – Gráfica
- 01-09 – Arquitectura – 4° piso
- 01-10 – Arquitectura – 4° piso – Gráfica
- 01-11 – Detalle escritorio MAu-1
- 01-12 – Detalle escritorio EAu
- 01-13 – Detalle isla I-2P
- 01-14 – Detalle tándem T-2P
- 01-15 – Detalle escritorio E-1P
- 01-16 – Detalle Isla I-4P
- 01-17 – Detalle Escritorio EsSE
- 01-18 – Detalle mesa de reunión chica MR-1
- 01-19 – Detalle mesa de reunión grande MR-2
- 01-20 – Detalle mesa de deliberación
- 01-21 – Detalle armario AR-B y AR-M
- 01-22 – Detalle armario AR-C y Cajonera CR

PLANTA BAJA

ITEM	BLOQUE	DESCRIPCION	CANTIDAD
MAu-1		ESCRITORIO RECTO P/PARTES SALA DE AUDIENCIAS 184x70x74	4 (CUATRO)
EAu		ESCRITORIO RECTO P/OPERADORES DE SALA DE AUDIENCIAS 100x70x74	2 (DOS)
SP		SILLON P/PUBLICO SALA DE AUDIENCIAS	12 (DOCE) SP-1 -color 1(6) SP-2 -color2(6)
SM I		SILLON P/MAGISTRADOS SALA DE AUDIENCIAS	2 (DOS)
SO I		SILLA OPERATIVA GIRATORIA	17 (DIECISIETE)
SFD		SILLA FISCALIA Y DEFENSA	16 (DIECISEIS)
I-2P		ISLA DE 2 PUESTOS 136x60x74	5 (CINCO)
T-2P		TANDEM DE 2 PUESTOS 240x70x74	1 (UNO)



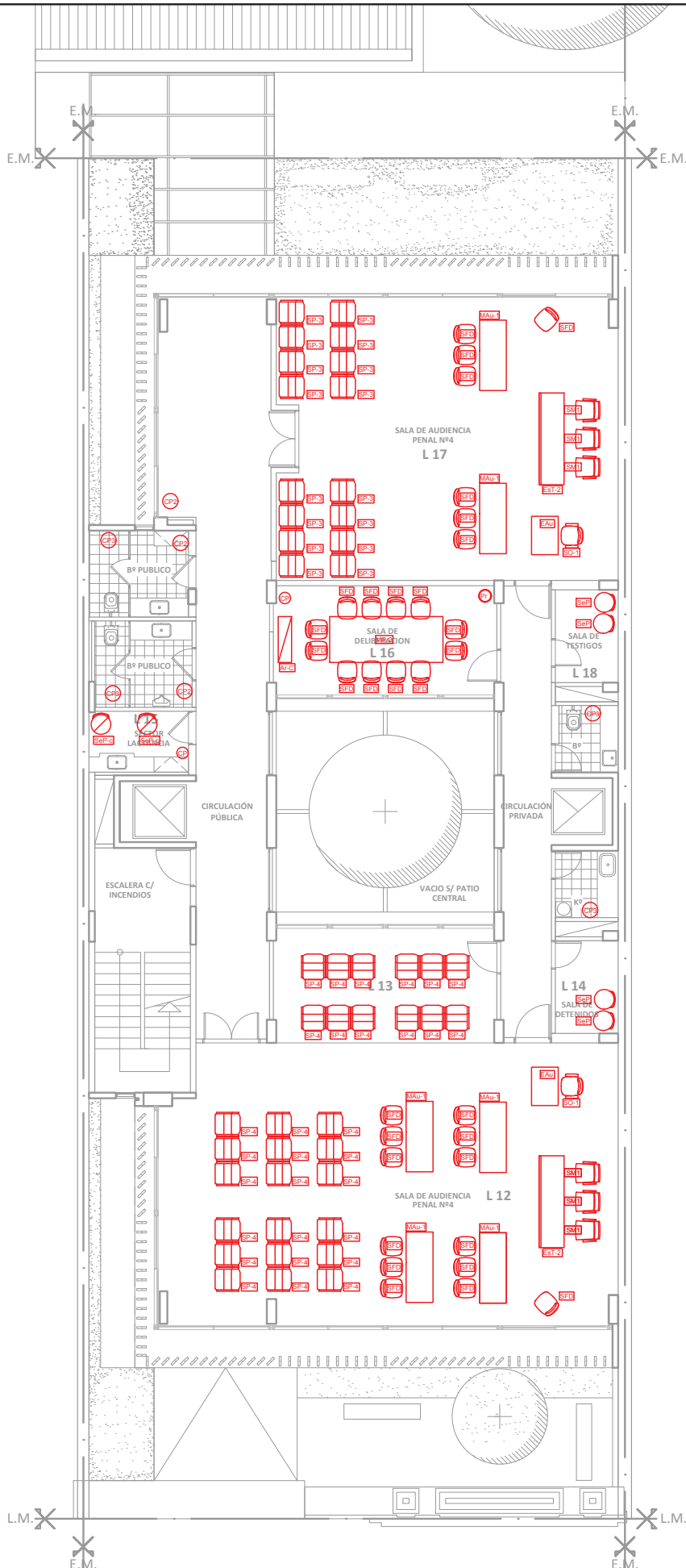



EsS		ESCRITORIO 1 PUESTO 136x70x74	1 (UNO)
ArB		ARMARIO BAJO 90x45x74	4 (CUATRO)
ArM		ARMARIO MEDIO 90x45x162	5 (CINCO)
CR		CAJONERA RODANTE 43x45x59.5	11 (ONCE)
CP		CESTOS DE PAPEL	8 (OCHO)
Pr		PERCHERO	1 (UNO)
Cp2		CESTOS DE PAPEL BAÑOS PUBLICOS	5 (CINCO)
Cp3		CESTOS DE PAPEL BAÑOS PRIVADOS Y KITCHEN	6 (SEIS)





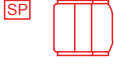



PLANTA 1º PISO

ESC: 1: 150

	P O D E R J U D I C I A L D E T U C U M A N	C E N T R O J U D I C I A L M O N T E R O S	FECHA: OCTUBRE 2020 N° PLANO: 01-03
	DIRECCION TECNICA SUR	A N E X O I I	ESCALA: 1:150
DIRECCION: ARQ. LAURA G. PRADO EQUIPO DE PROYECTO Y OBRAS ARQ. MARTIN CALDELARI - ARQ. BENJAMIN GUARDIA ARQ. MARIANGELES GALUP - ARQ. ROBERTO GERIA		PLANO:	PLIEGO MOBILIARIO - ARQUITECTURA - 1º PISO
H I G I E N E Y S E G U R I D A D : L I C E N C I A D A C E C I L I A I M P A			

ITEM	BLOQUE	DESCRIPCION	CANTIDAD
MAu-I		ESCRITORIO RECTO P/PARTES SALA DE AUDIENCIAS 184x70x74	6 (SEIS)
EaU		ESCRITORIO RECTO P/OPERADORES DE SALA DE AUDIENCIAS 100x70x74	2 (DOS)
SP		SILLON P/PUBLICO SALA DE AUDIENCIAS	46 (CUARENTA Y SEIS) SP-3-color 3 (16) sp-4 -color4 (30)
SM I		SILLON P/MAGISTRADOS SALA DE AUDIENCIAS	6 (SEIS)
SeP		SILLA DE ESPERA PUBLICO	4 (cuatro)
SeP-c		SILLA DE ESPERA PUBLICO COLOR	2 (DOS)
SFD		SILLA FISCALIA Y DEFENSA	32 (TREINTA Y DOS)

MR-2		MESA DE REUNION	1 (UNA)
ArC		ARMARIO BAJO largo 120x35x74	1 (UNO)
SO I		SILLA OPERATIVA GIRATORIA	2 (DOS)
CP		CESTOS DE PAPEL	2 (DOS)
Pr		PERCHERO	1 (UNO)
Cp2		CESTOS DE PAPEL BAÑOS PUBLICOS	3 (TRES)
Cp3		CESTOS DE PAPEL BAÑOS PRIVADOS Y KITCHEN	4 (CUATRO)

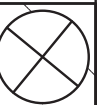

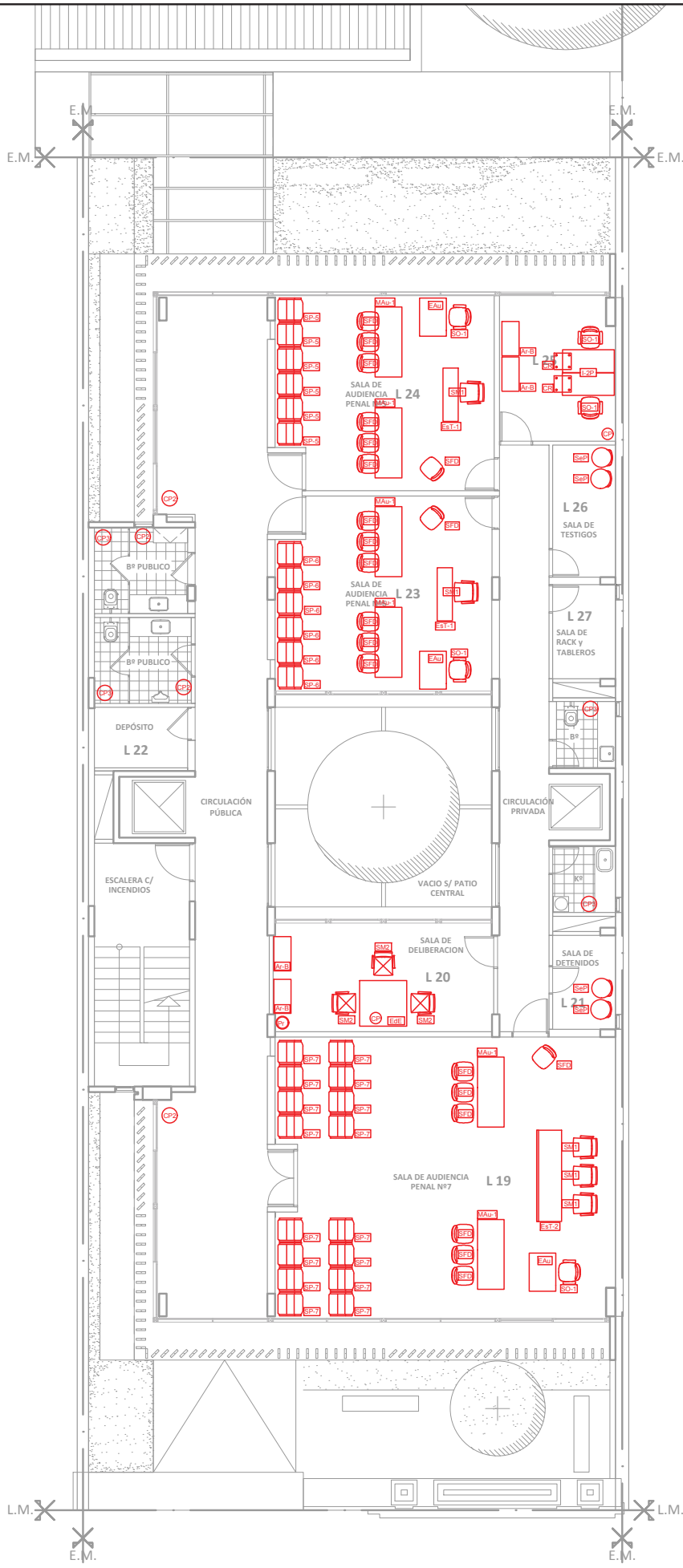









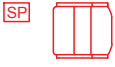



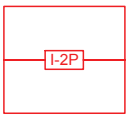

PLANTA 2º PISO

ESC: 1: 150

	P O D E R J U D I C I A L D E T U C U M A N	C E N T R O J U D I C I A L M O N T E R O S	FECHA: OCTUBRE 2020 N° PLANO: 01-05
	DIRECCION TECNICA SUR	A N E X O I I	ESCALA: 1:150
DIRECCION: ARQ. LAURAG. PRADO EQUIPO DE PROYECTO Y OBRAS ARQ. MARTIN CALDELARI - ARQ. BENJAMIN GUARDIA ARQ. MARIANGELES GALUP - ARQ. ROBERTO GERIA		PLANO:	PLIEGO MOBILIARIO - ARQUITECTURA - 2º PISO
H I G I E N E Y S E G U R I D A D : L I C E N C I A D A C E C I L I A I M P A			

ITEM	BLOQUE	DESCRIPCION	CANTIDAD
MAu-1		ESCRITORIO RECTO P/PARTES SALA DE AUDIENCIAS 184x70x74	6 (SEIS)
EAu		ESCRITORIO RECTO P/OPERADORES DE SALA DE AUDIENCIAS 100x70x74	3 (TRES)
SP		SILLON P/PUBLICO SALA DE AUDIENCIAS	28 (VEINTI OCHO) SP-5-color 5 (6) SP-6-color 6 (6) sp-7-color 7 (16)
SM I		SILLON P/MAGISTRADOS SALA DE AUDIENCIAS	5 (CINCO)
SeP		SILLA DE ESPERA PUBLICO	4 (CUATRO)
SFD		SILLA FISCALIA Y DEFENSA	21 (VEINTI UNO)
SO I		SILLA OPERATIVA GIRATORIA	5 (CINCO)
SM 2		SILLON MAGISTRADO MEDIO	3 (TRES)
ArB		ARMARIO BAJO 90x45x74	4 (CUATRO)

I-2P		ISLA DE 2 PUESTOS 136x60x74	1 (UNA)
EdE		MESA DE DELIBERACION 124x120x74	1 (UNA)
CR		CAJONERA RODANTE 43x45x59.5	2 (DOS)
CP		CESTOS DE PAPEL	2 (DOS)
Pr		PERCHERO	1 (UNO)
Cp2		CESTOS DE PAPEL BAÑOS PUBLICOS	4 (CUATRO)
Cp3		CESTOS DE PAPEL BAÑOS PRIVADOS Y KITCHEN	4 (CUATRO)

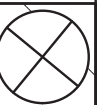

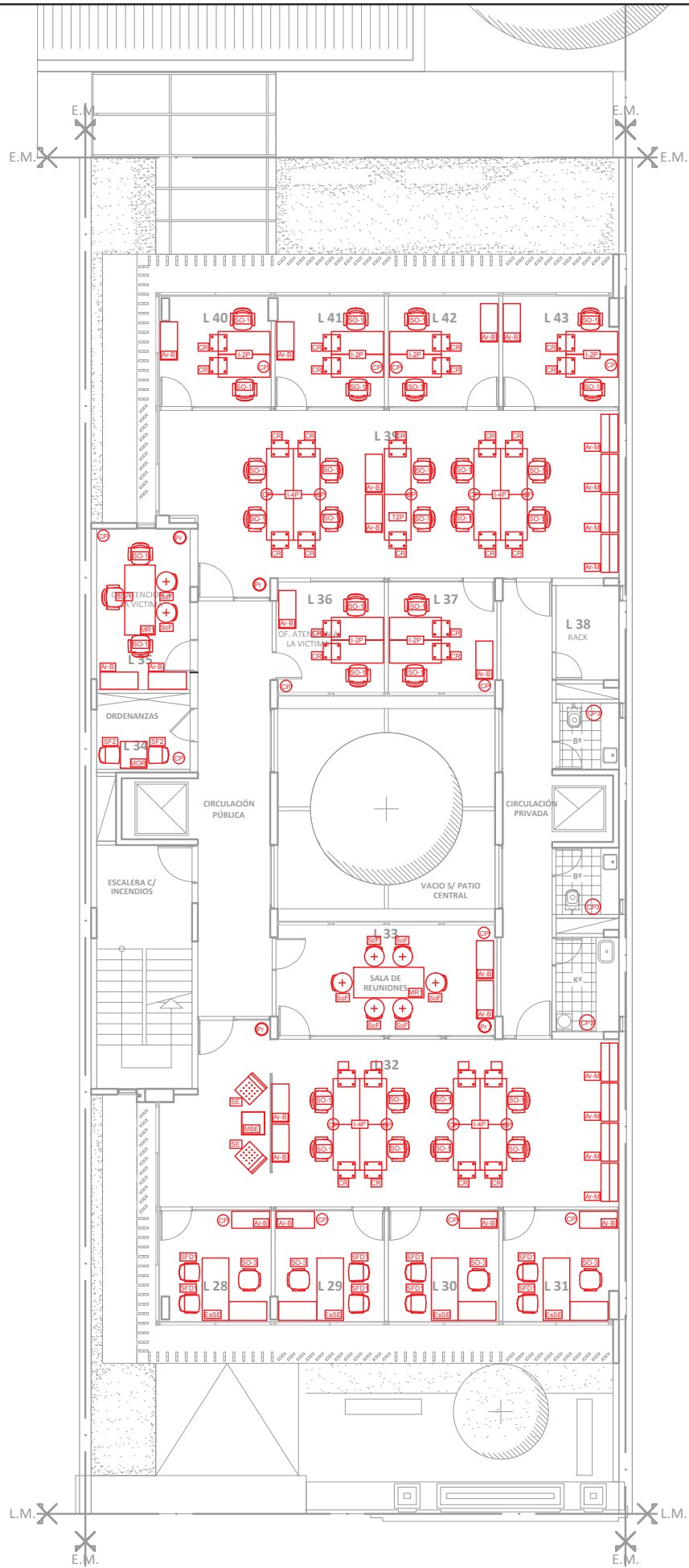















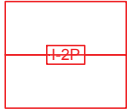
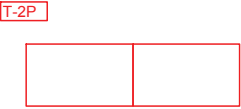

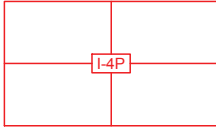
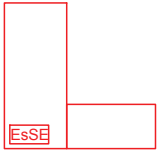
PLANTA 3º PISO

ESC: 1: 150

	OCTUBRE 2020
	01-07
C E N T R O J U D I C I A L M O N T E R O S A N E X O I	PLANO: PLIEGO MOBILIARIO - ARQUITECTURA - 3º PISO
DIRECCION TECNICA SUR HIGIENE Y SEGURIDAD: LICENCIADA CECILIA IMPA	ESCALA: 1:150
DIRECCION: ARQ. LAURA GRADO EQUIPO DE PROYECTO OBRAS ARQ. MARTIN CALDELARI - ARQ. BENJAMIN GUARDIA ARQ. MARIANGELES GALUP - ARQ. ROBERTO GERIA	

ITEM	BLOQUE	DESCRIPCION	CANTIDAD
MOR		MESA ORDENANZA 70x70x75	1 (UNA)
SoF		SILLA ESPERA TAPIZADA	8 (OCHO)
SO 1		SILLA OPERATIVA GIRATORIA	33 (TREINTA Y TRES)
SFD1		SILLA PUBLICO OFICINAS	8 (OCHO)
SO 3		SILLA GIRATORIA JEFES	4 (CUATRO)
SF2		SILLA ORDENANZAS	2 (DOS)
SE		SILLON DE ESPERA	2 (DOS)
MBE		MESA DE ESPERA 60x60x41	1 (UNA)
I-2P		ISLA DE 2 PUESTOS 136x60x74	6 (SEIS)
T-2P		TANDEM DE 2 PUESTOS 240x70x74	1 (UNO)

I-4P		ISLA DE 4 PUESTOS 240x140x74	4 (CUATRO)
EsSE		ESCRITORIO CON EXTENSION 164x70x74 100x45x74	4 (CUATRO)
MRI		MESA DE REUNION 184x80x74	2 (DOS)
ArB		ARMARIO BAJO 90x45x74	18 (DIECI OCHO)
ArM		ARMARIO MEDIO 90x45x162	8 (OCHO)
CR		CAJONERA RODANTE 43x45x59.5	30 (TREINTA)
CP		CESTOS DE PAPEL	22 (VEINTI DOS)
Pr		PERCHERO	4 (CUATRO)
Cp3		CESTOS DE PAPEL BAÑOS PRIVADOS Y KITCHEN	3 (TRES)



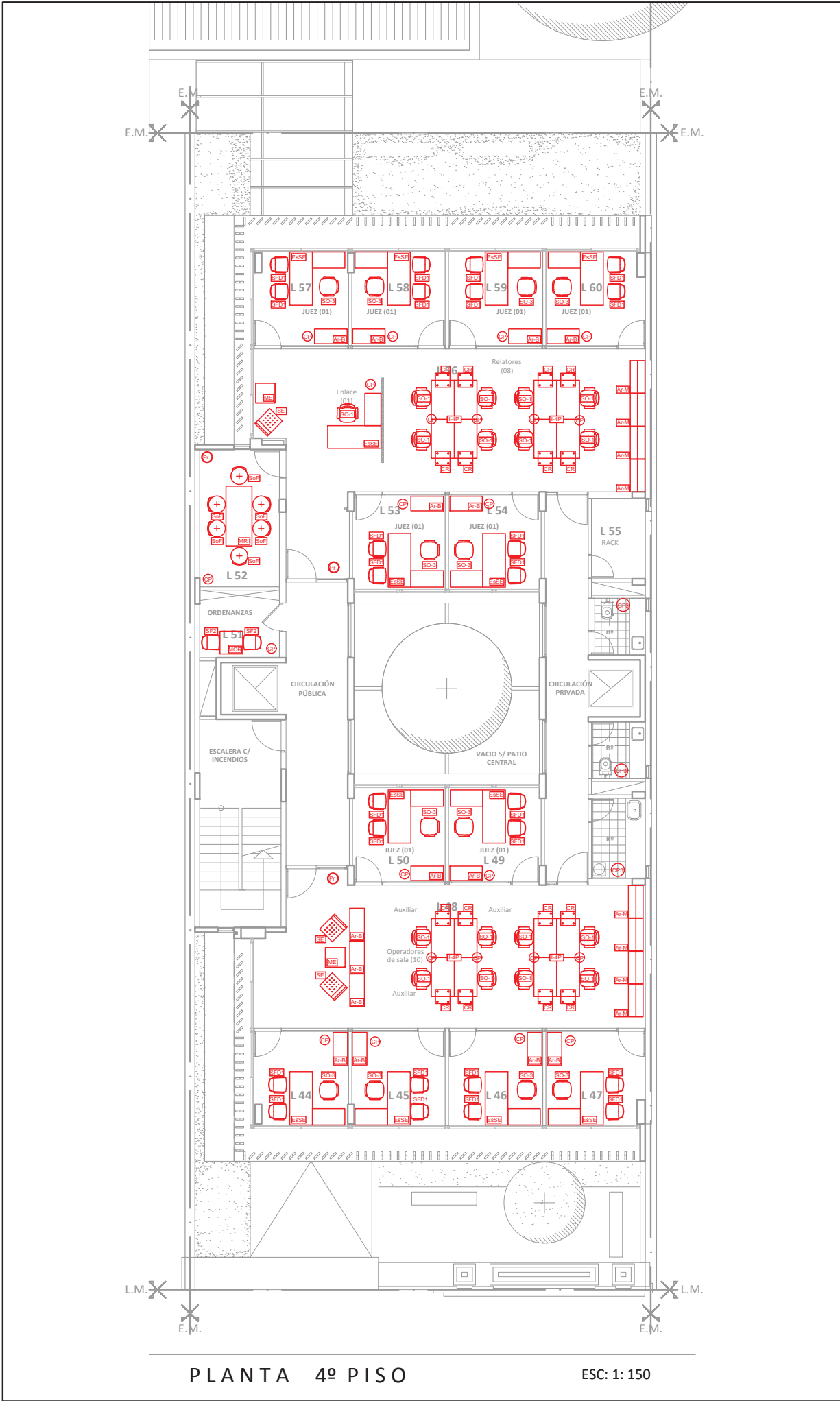















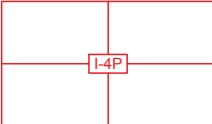

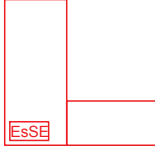
PLANTA 4º PISO

ESC: 1: 150

	REGIA OCTUBRE 2020 N° PLANO: 01-09
	ESCALA: 1:150
P O D E R J U D I C I A L D E T U C U M A N	C E N T R O J U D I C I A L M O N T E R O S
DIRECCION TECNICA SUR	A N E X O I I
M I G I E N E Y S E G U R I D A D : L I C E N C I A D A C E C I L I A I M P A	PLANO: PLIEGO MOBILIARIO - ARQUITECTURA - 4º PISO
DIRECCION: ARQ. LAURA G. PRADO EQUIPO DE PROYECTO Y OBRAS ARQ. MARTIN CALDELARI - ARQ. BENJAMIN GUARDIA ARQ. MARIANGELES GALUP - ARQ. ROBERTO GERIA	
	REGIA OCTUBRE 2020 N° PLANO: 01-09
	ESCALA: 1:150

ITEM	BLOQUE	DESCRIPCION	CANTIDAD
MOR		MESA ORDENANZA 70x70x75	1 (UNA)
SoF		SILLA ESPERA TAPIZADA	6 (SEIS)
SO 1		SILLA OPERATIVA GIRATORIA	17 (DIECI SIETE)
SFD1		SILLA PUBLICO OFICINAS	24 (VEINTI CUATRO)
SO 3		SILLA GIRATORIA JEFES	12 (DOCE)
SF2		SILLA ORDENANZAS	2 (DOS)
SE		SILLON DE ESPERA	3 (TRES)
MBE		MESA DE ESPERA 60x60x41	2 (DOS)
I-4P		ISLA DE 4 PUESTOS 240x140x74	4 (CUATRO)

EsSE		ESCRITORIO CON EXTENSION 164x70x74 100x45x74	13 (TRECE)
MRI		MESA DE REUNION 184x80x74	1 (UNA)
ArB		ARMARIO BAJO 90x45x74	15 (QUINCE)
ArM		ARMARIO MEDIO 90x45x162	8 (OCHO)
CR		CAJONERA RODANTE 43x45x59.5	16 (DIECISEIS)
CP		CESTOS DE PAPEL	23 (VEINTI TRES)
PR		PERCHERO	3 (TRES)
Cp3		CESTOS DE PAPEL BAÑOS PRIVADOS Y KITCHEN	3 (TRES)

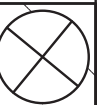
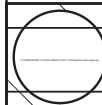

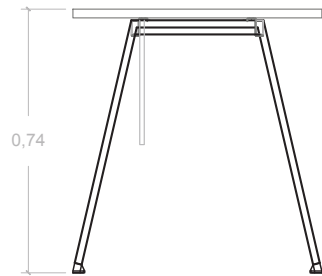

MAu-1
ESCRITORIO PARA PARTES
184x70x74

ESTRUCTURA CAÑO 80/20 x 2MM Y 40/20 x 1.2 y
 2mm COLOR ALUMINIO
 TAPA MELAMINA de 1840x700mm S/MDF 25 MM
 COLOR CENIZA, CANTOS ABS AL TONO

CANTIDAD: 16 (DIECISEIS)

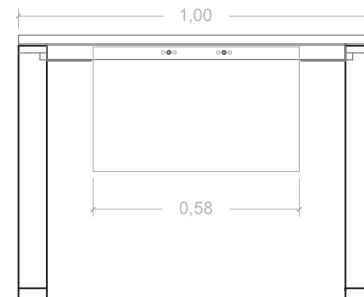
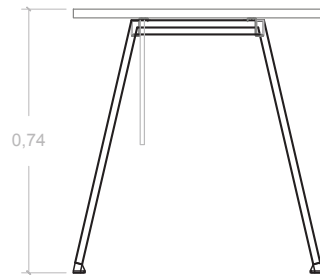

EaU
ESCRITORIO RECTO CON TAPAPIERNAS
100x70x74

ESTRUCTURA CAÑO 80/20 x 2MM Y 40/20 x 1.2 y
 2mm COLOR ALUMINIO
 TAPA MELAMINA de 1000x700mm S/MDF 25 mm
 COLOR CENIZA, CANTOS ABS AL TONO

CANTIDAD: 7 (SIETE)

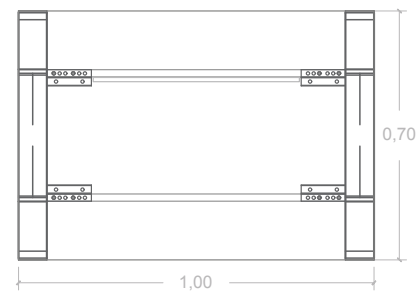

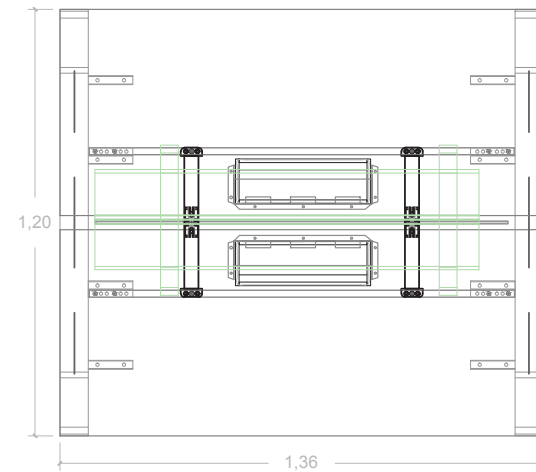
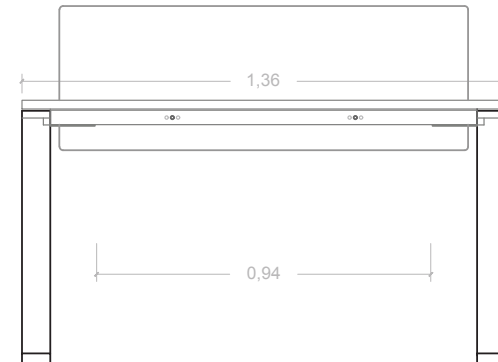
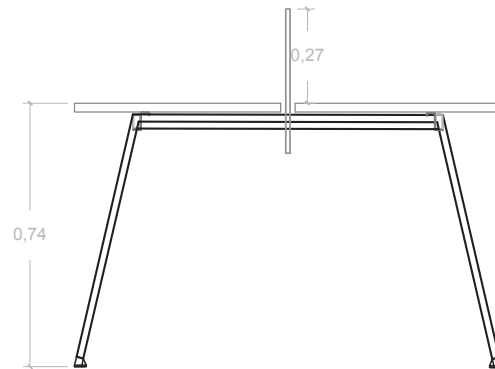

I-2P
ISLA DE 2 PUESTOS
136x120x74

ESTRUCTURA CAÑO 80/20 x 2MM Y 40/20 x 1.2 y 2mm
 COLOR ALUMINIO
 TAPA MELAMINA de 1360x680mm S/MDF 25 mm
 COLOR CENIZA, CANTOS ABS AL TONO

INCLUYE BOCA tipo AI3 + BASTIDOR DE 3 + BANDEJA 180T
 + PANTALLA100x298mm

CANTIDAD: 12 (DOCE)



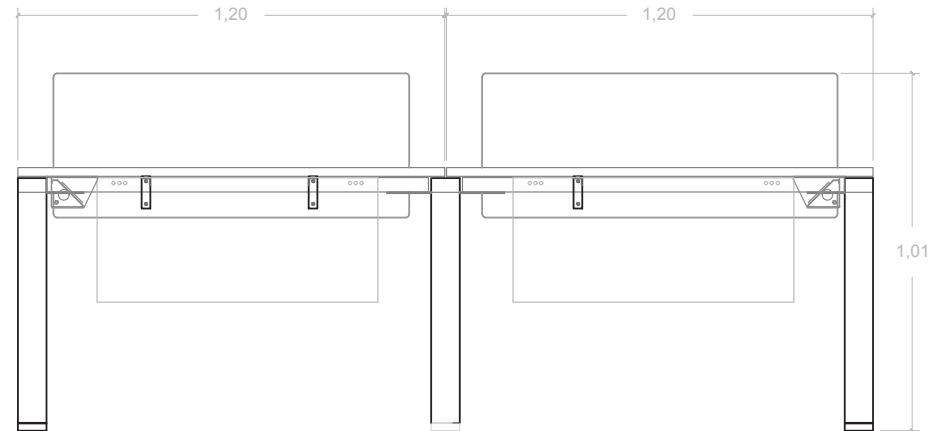
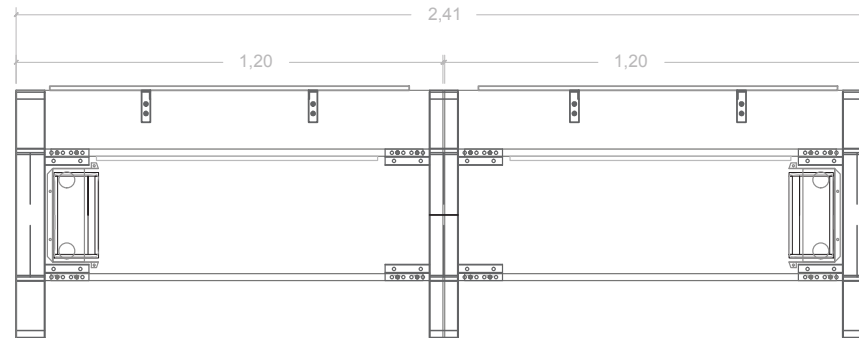
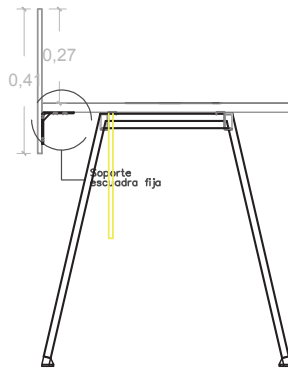

T-2P
TANDEM DE 2 PUESTOS
240x70x74

ESTRUCTURA CAÑO 80/20 x 2MM Y
 40/20 x 1.2 y 2mm COLOR ALUMINIO
 TAPA MELAMINA de 1200x700mm
 S/MDF 25 mm
 COLOR CENIZA, CANTOS ABS AL TONO

INCLUYE BOCA tipo A13 + BASTIDOR DE 3
 + BANDEJA 180T + PANTALLA100x298mm

CANTIDAD: 2 (DOS)



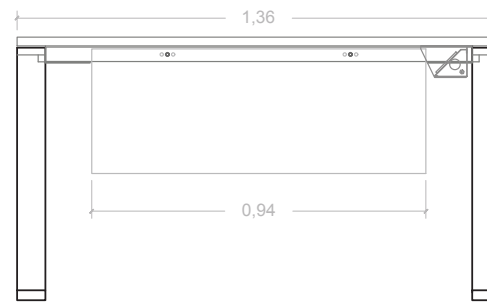
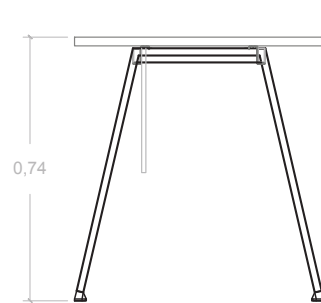

E-1P
ESCRITORIO DE 1 PUESTO

136x70x74

ESTRUCTURA CAÑO 80/20 x 2MM Y 40/20 x 1.2 y 2mm
COLOR ALUMINIO
TAPA MELAMINA de 1360x700mm S/MDF 25 mm
COLOR CENIZA, CANTOS ABS AL TONO

INCLUYE BOCA tipo A13 + BASTIDOR DE 3 + BANDEJA
180T + PANTALLA100x298mm

CANTIDAD: 2 (DOS)



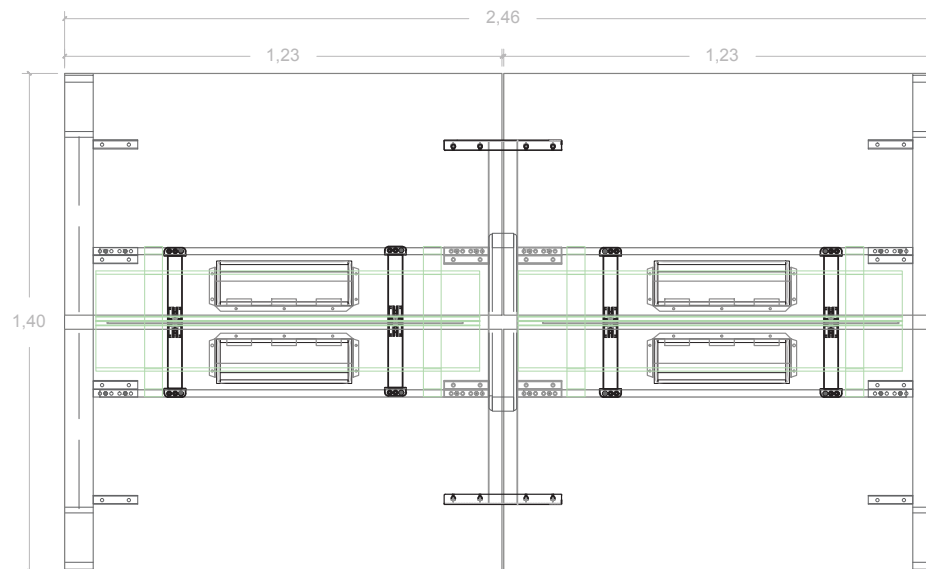

I-4P

ISLA DE 4 PUESTOS

240x140x74

ESTRUCTURA CAÑO 80/20 x 2MM Y 40/20 x 1.2 y 2mm COLOR ALUMINIO

TAPA MELAMINA de 680x1220mm S/MDF 25 mm

COLOR CENIZA, CANTOS ABS AL TONO

INCLUYE BOCA tipo A13 + BASTIDOR DE 3 + BANDEJA 180T + PANTALLA100x298mm

CANTIDAD: 8 (OCHO)

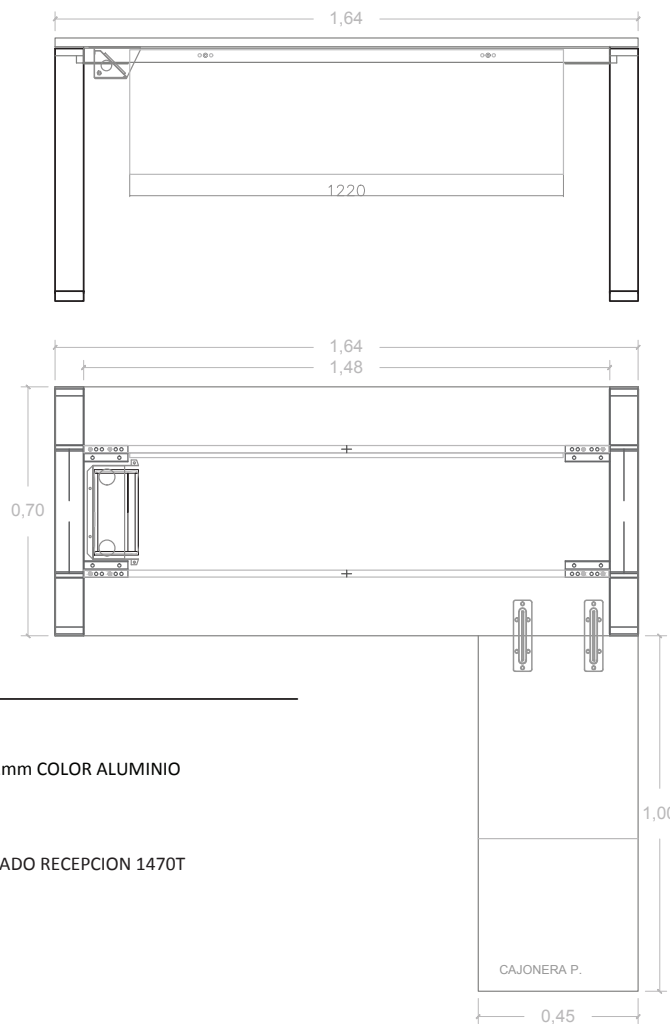

EsSE

ESCRITORIO FUNCIONARIOS

164x70x74 + 100x45x74

ESTRUCTURA CAÑO 80/20 x 2MM Y 40/20 x 1.2 y 2mm COLOR ALUMINIO

TAPA MELAMINA de 1640x700mm S/MDF 25 mm

COLOR CENIZA, CANTOS ABS AL TONO

INCLUYE BOCA tipo A13 + BASTIDOR DE 2rec + PLEGADO RECEPCION 1470T

CANTIDAD: 8 (OCHO)

CAJONERA P.

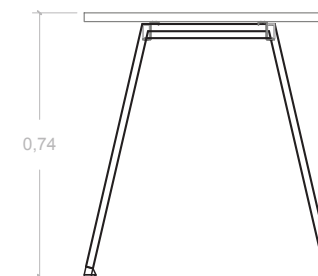
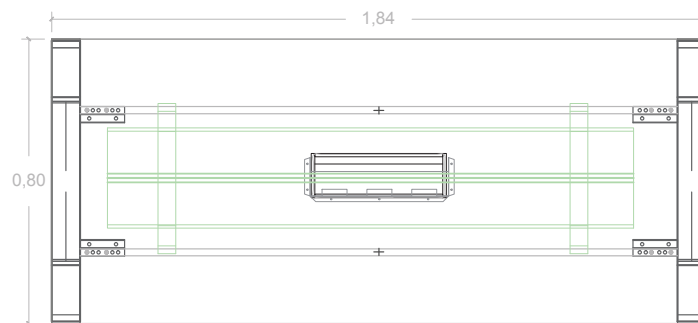

MR-1
MESA DE REUNION CHICA

184x80x74

ESTRUCTURA CAÑO 80/20 x 2MM Y 40/20 x 1.2 y 2mm COLOR ALUMINIO
 TAPA MELAMINA de 1840x800mm S/MDF 25 MM COLOR CENIZA, CANTOS ABS AL TONO
 INCLUYE BOCA tipo AI3 + BASTIDOR DE 3 + BANDEJA 1480T

CANTIDAD: 3 (TRES)

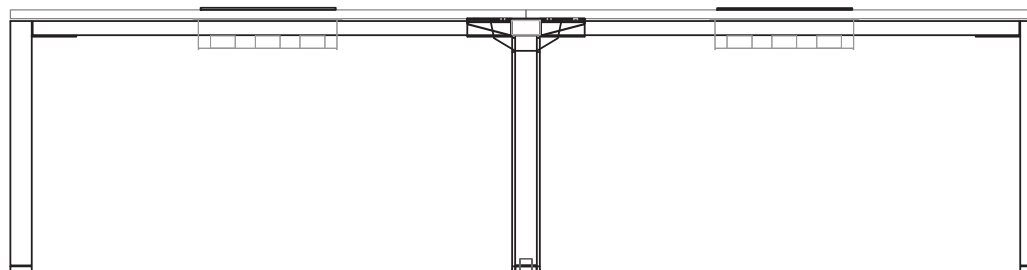
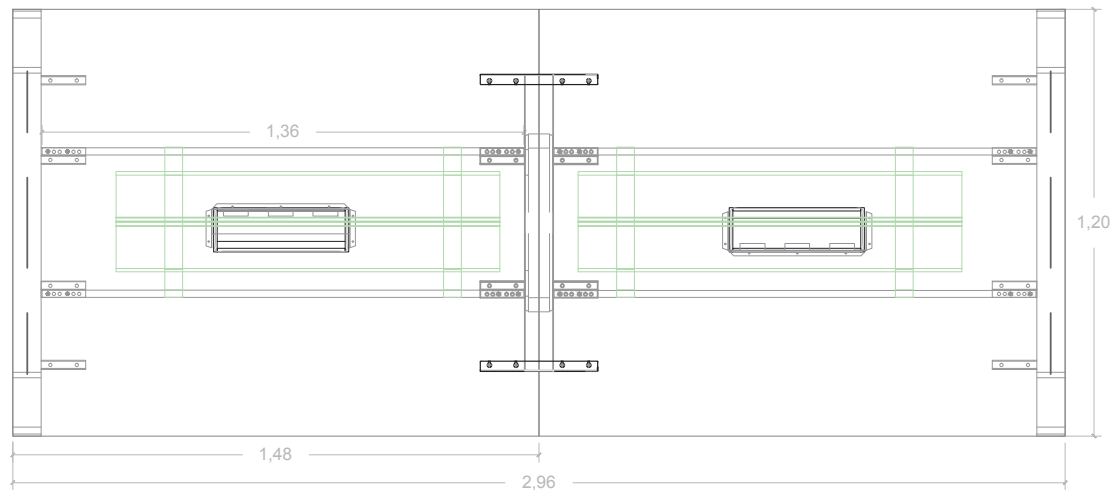

MR-2
MESA DE REUNION GRANDE
296x120x74

ESTRUCTURA CAÑO 80/20 x 2MM Y 40/20 x 1.2 y 2mm COLOR ALUMINIO TAPA MELAMINA de 1840x800mm S/MDF 25 MM COLOR CENIZA, CANTOS ABS AL TONO INCLUYE BOCA tipo A13 + BASTIDOR DE 3 + BANDEJA 1480T

CANTIDAD: 1 (UNA)



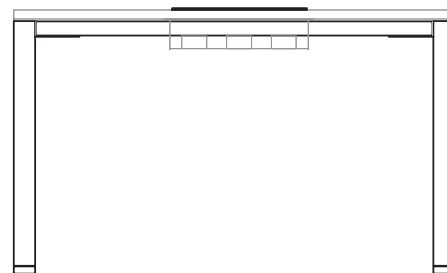
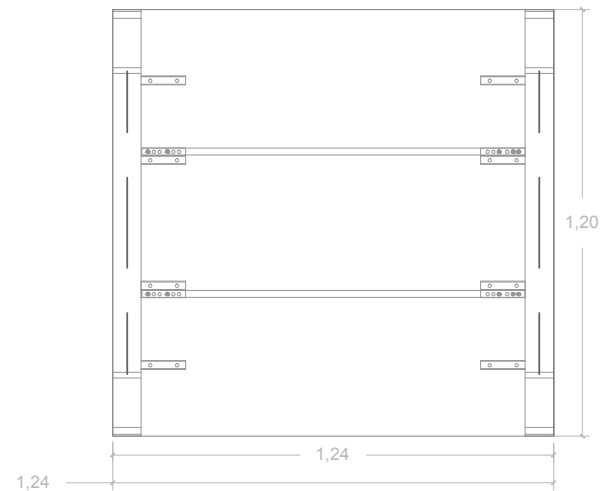

EdE
MESA DE DELIBERACION
124x120x74

ESTRUCTURA CAÑO 80/20 x 2MM Y
 40/20 x 1.2 y 2mm COLOR
 ALUMINIO TAPA MELAMINA de
 1840x800mm S/MDF 25 MM COLOR
 CENIZA, CANTOS ABS AL TONO

CANTIDAD: 1 (UNA)

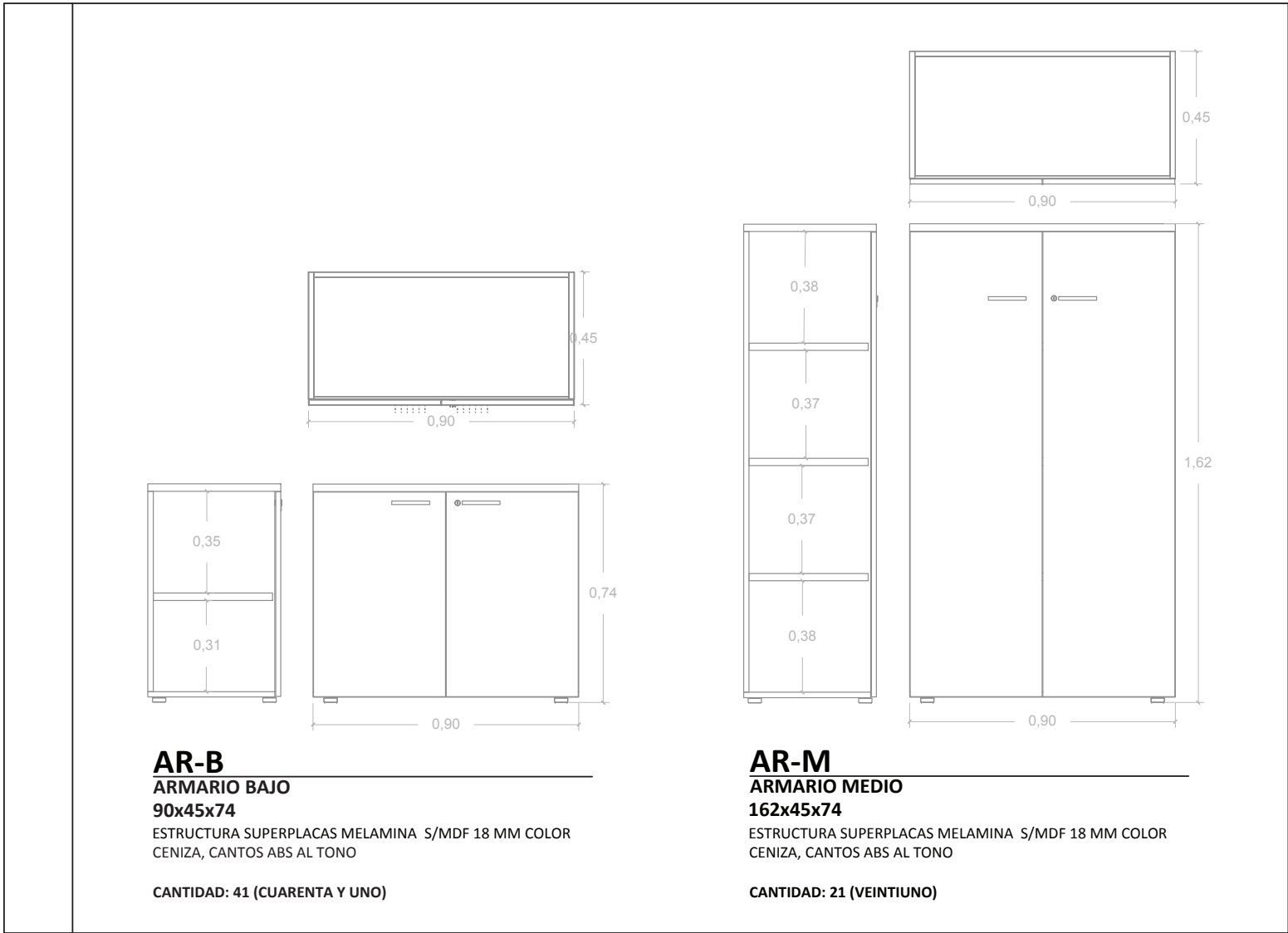

PODER JUDICIAL DE TUCUMÁN
DIRECCION TECNICA SUR

DIRECCION: ARQ. LAURA G. PRADO EQUIPO DE PROYECTO Y OBRAS:
 ARQ. MARTIN CALDELARI - ARQ: BENJAMIN GUARDIA
 ARQ. MARIANGELES GALUP - ARQ: ROBERTO GERIA

HIGIENE Y SEGURIDAD:
 LICENCIADA CECILIA IMPA

CENTRO JUDICIAL MONTEROS
A N E X O I I I

PLANO: PLIEGO MOBILIARIO - DETALLE ARMARIO AR-B Y AR-M

FECHA: OCTUBRE 2020
 ESCALA: 1 : 2 0
 N° PLANO: 01-21



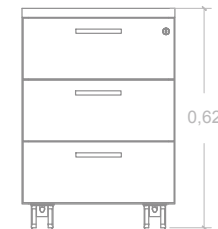
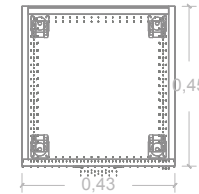
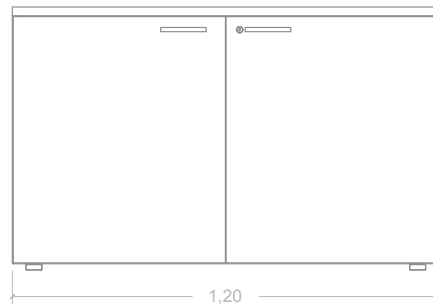
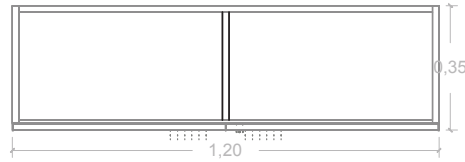
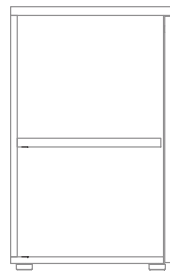

AR-C

ARMARIO BAJO LARGO

120x35x74

ESTRUCTURA SUPERPLACAS MELAMINA S/MDF 18 MM COLOR CENIZA, CANTOS ABS AL TONO

CANTIDAD: 1 (UNO)

CR

CAJONERA RODANTE

46x45x62

ESTRUCTURA SUPERPLACAS MELAMINA S/MDF 18 MM COLOR CENIZA, CANTOS ABS AL TONO

CANTIDAD: 59 (CINCUENTA Y NUEVE)